

# *Increasing Physical Activity*



## *Through Community Design*

*A Guide for Public Health Practitioners*

May 2002

*National Center for Bicycling & Walking*

1506 21st Street NW, Washington, DC 20036

W.C. Wilkinson, N. Eddy, G. MacFadden and B. Burgess.  
*Increasing Physical Activity Through Community Design: A  
Guide for Public Health Practitioners*. Washington: National  
Center for Bicycling & Walking, May 2002.

Support for this publication was provided by a grant  
from The Robert Wood Johnson Foundation®, Princeton,  
New Jersey.

Additional copies of this report are available from the  
National Center for Bicycling & Walking. The report may  
be downloaded at [www.bikewalk.org](http://www.bikewalk.org).

# Increasing Physical Activity

A Guide for

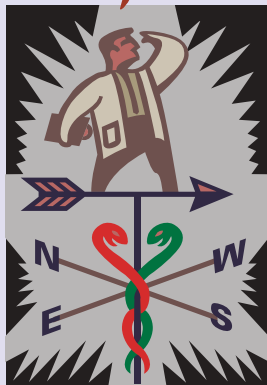

Public Health  
Practitioners

# Through Community Design

## Chapter One: Introduction

Summary .....	1
Health, Physical Activity & Community Design .....	2
<i>A Health Crisis</i> .....	2
<i>Daily Physical Activity</i> .....	3
<i>Active Living Through Community Design</i> .....	5
Treating the Patient .....	8

## Chapter Two: How to Improve Conditions for Walking and Bicycling

What's Your Role? .....	9
What Needs Doing? .....	11
<i>Community Audit</i> .....	12
<i>More, Better Sidewalks</i> .....	15
<i>Safe &amp; Convenient Crossings</i> .....	17
<i>Bicycle-Friendly Streets</i> .....	19
<i>Trails</i> .....	21
<i>Slow Down Motor Vehicles</i> .....	23
<i>Safe Routes to School</i> .....	25

## Chapter Three: How to Get it Funded

Develop a Strategy .....	28
<i>Maintenance</i> .....	28
<i>Capital Improvements</i> .....	29
<i>Private Development</i> .....	30
Identify Funding Sources .....	31
<i>State and Local Road Projects</i> .....	31
<i>Federal Programs</i> .....	31
<i>Local Revenue Sources</i> .....	37
<i>Private Donations</i> .....	38
Follow Through with the Project .....	39
Summary .....	39

## Chapter Four: Resources

Public Health Facts & Figures .....	41
Transportation Facts & Figures .....	41
Land-Use Planning & Community Design .....	42
Facility Planning & Design .....	43
Schools .....	44
Funding Sources & Programs .....	44
Advocacy .....	45
Glossary & Index .....	46

*"If you design an environment for children, it will work for everyone."*

–Larry Beasley, Director of Central-Area Planning, Vancouver, B.C.



***Photos by:***

Dan Burden, *Walkable Communities*

Cover; pages iv, 1, 8, 11, 12, 14, 15, 17, 19, 23, 24, 25, & 40.

Bruce Burgess, *National Center for Bicycling & Walking*

Pages 16 & 21.

Nils Eddy, *Technical Writer-Editor-Photographer*

Pages 5, 9, 22, 28 & 30.

Michael Ronkin, *Oregon Department of Transportation*

Page 20.



# Overview

## Summary

In healthy communities — not just in the movies — walking and bicycling are a normal part of daily life. The Centers for Disease Control and Prevention (CDC) call these kinds of places *Active Community Environments* (ACEs). They recognize that providing for active living through community design is a health issue.

This guide tells you how to help create places for people to walk and bicycle. This doesn't just mean special trails, though those might certainly be an important element of an overall plan. Creating an active community environment means taking a look at the broader scope of where there are — and aren't — opportunities to safely walk and bicycle. It involves land use design, retrofitting the transportation infrastructure, funding and much more.

Although this guide is written for public health professionals, others — community leaders, local planners and transportation agency officials, and citizens — can also benefit from reading it because poor community design affects the health of the entire community. The increased awareness each of us brings to the problem is another step towards the solution.



Four interrelated aspects of a community.

*“Part of what we’ve done is to engineer an epidemic of obesity. I would hope we could engineer ourselves out of this as well.”*

—Katrina Hedberg, MD, MPH, Deputy State Epidemiologist, State of Oregon Health Division



Two streets of similar function but the left design ignores the needs of an active community.

### Chapter One: Overview

- Summary ..... 1
- Health, Physical Activity & Community Design ..... 2
  - A Health Crisis* ..... 2
  - Daily Physical Activity* ..... 3
  - Active Living Through Community Design* ..... 5
- Treating the Patient ..... 8
- See also: Glossary & Index ..... 46

**Adult Obesity Trends**

(Body Mass Index  $\geq 30$ , or  $\sim 30$  lbs overweight for 5'4" woman)

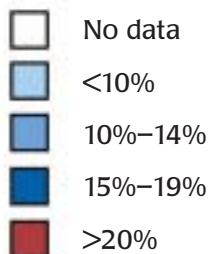
**1985****1990****1995****2000**

Obesity has increased in men and women across all socio-demographic groups and all regions. In 1985, none of the 20 participating states had obesity rates of 15% or more; by 1995, 27 states did. In 1995, none of the states had obesity rates of 20% or more; by 1998, such rates were seen in 7 states and in 2000, in 22 states.

–A. Mokdad, et al., CDC, *The Continuing Epidemic of Obesity in the United States*, Journal of the American Medical Association, October 4, 2000

# Health, Physical Activity & Community Design

## A Health Crisis

America faces a national health crisis of epidemic proportions. Physical inactivity combined with overeating has, in just a few decades, made us a nation of fat and out-of-shape people. The incidence of overweight or obese adults increased steadily from 47 percent in 1976, to 56 percent in 1994, and 61 percent in 1999. The prevalence of overweight children and adolescents almost doubled during the same period.

### Recommended Physical Activity

- It is recommended that Americans accumulate at least 30 minutes (adults) or 60 minutes (children) of moderate physical activity most days of the week. More may be needed to prevent weight gain, to lose weight or to maintain weight loss.
- Less than 1/3 of adults engage in the recommended amount of physical activity.
- Many people live sedentary lives; 40 percent of adults in the United States do not participate in any leisure time physical activity.
- 43 percent of adolescents watch more than 2 hours of television each day.
- Physical activity is important in preventing and treating overweight and obesity and is extremely helpful in maintaining weight loss, especially when combined with healthy eating.

–Surgeon General's *Overweight and Obesity At a Glance*, 2001

Obesity, diabetes, heart disease, stress and a host of other ills are increasing. Physical inactivity and obesity rank second to smoking in their contribution to total mortality in the United States. Nearly 80 percent of obese adults have diabetes, high blood cholesterol levels, high blood pressure, coronary artery disease or other ailments (K. Flegal, et al., *Overweight and obesity in the United States: prevalence and trends, 1960-1994*, Int J Obesity, 1998).

About 60 percent of overweight children between five and 10 years of age already demonstrate risk factors such as elevated blood pressure and increased insulin levels associated with heart disease. These factors lead to chronic diseases later in life.

## Daily Physical Activity

Moderate, daily physical activity, such as bicycling or walking, has long been recognized as an essential ingredient of a healthy lifestyle. Yet many Americans, both young and old, lead a sedentary lifestyle. Our workplaces are increasingly automated. Many jobs require workers to spend hours at a desk. We use the automobile as our primary means of travel even for short trips.

According to the U.S. Department of Transportation's Nationwide Personal Transportation Survey, the number of trips the average American adult takes on foot each year dropped 42 percent between 1975 and 1995.

Among children, walking trips dropped 37 percent. Only 10 percent of public school students are estimated to walk to school today compared to a majority of students a generation ago. The most common means of transportation to school is by car.

We prepare our children for a sedentary lifestyle. At school, opportunities for physical activity have diminished. Shifting priorities have caused many physical education classes and even recesses to be dropped. After school, kids are driven to events, to the mall or to a friend's house. Add in a daily dose of television, often accompanied by high-calorie snack foods, and it's no wonder that so many young people find themselves outside the recommended height/weight range.

The increase in obesity follows a decline in walking and bicycling. We use the automobile for even the shortest trips. About 25 percent of all trips made in the United States are less than one mile in length, and 75 percent of those short trips are made by automobile (1995 Nationwide Personal Transportation Survey).

We don't walk or bicycle as much as we used to, partly because our communities — designed around the automobile — lack walkways and bikeways that would otherwise accommodate and encourage such activity. Even where facilities exist, features that support driving, such as wide roads and intersections, large parking lots and drive-through businesses, create an environment that is uncomfortable and unsafe for nonmotorists.

Spread-out, isolated destinations typical of car-oriented suburban development also discourage walking and bicycling. Even in communities where most places are near enough to walk or bicycle, people may not feel safe because of high motor vehicle speeds and volumes.

*"Our young people need help to get moving... Nearly half of all young people do not take part in regular, vigorous physical activity, and less than half of all high school students have regular physical education classes at school..."*

—David Satcher, Surgeon General, remarks at *First International Walk to School Day*, 2000

### Less Walking & Bicycling, More Driving

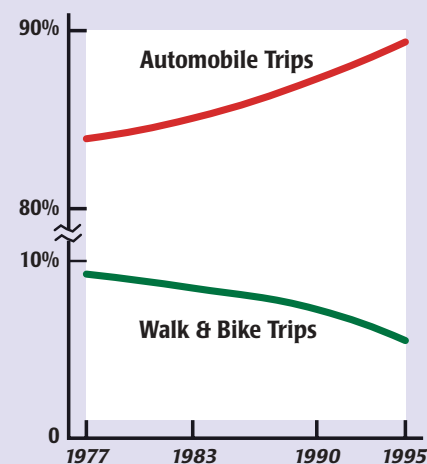

Source: Nationwide Personal Transportation Survey

### Most Children Driven or Bused to School

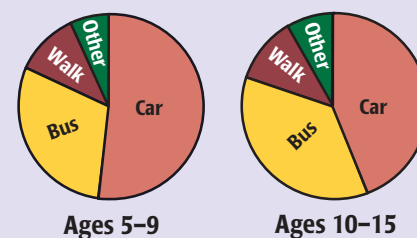

Source: Nationwide Personal Transportation Survey (1995)



### **Benefits of Daily Physical Activity**

According to the American Heart Association, daily physical activity:

- Reduces the risk of heart disease by improving blood circulation throughout the body.
- Keeps weight under control.
- Improves blood cholesterol levels.
- Prevents and manages high blood pressure.
- Prevents bone loss.
- Boosts energy level.
- Helps manage stress.
- Releases tension.
- Improves the ability to fall asleep quickly and sleep well.
- Improves self-image.
- Counters anxiety and depression and increases enthusiasm and optimism.
- Increases muscle strength and the ability to do other physical activities.
- Provides a way to share an activity with family and friends.
- Establishes healthy habits in children and counters the conditions (obesity, high blood pressure, etc.) that lead to heart attack and stroke later in life.
- Helps delay or prevent chronic illnesses and diseases associated with aging and maintains quality of life and independence longer.

---

*"In 2000... 28 percent of U.S. adults did not engage in any physical activity, and another 28 percent were not regularly active.... The prevalence of obesity and diabetes continues to increase among U.S. adults. Interventions are needed to improve physical activity and diet in communities nationwide."*

*—Obesity and Diabetes are Major Causes of Morbidity and Mortality in the United States, Journal of the American Medical Association, 2001*

---

---

*"It is now clear that regular physical activity reduces the risk for coronary heart disease, diabetes, colon cancer, and several other major chronic diseases and conditions."*

*—Physical Activity and Health: A Report of the Surgeon General, 1996*

---



## Active Living Through Community Design

### The Vision

The CDC refers to places where everyone can enjoy daily, moderate levels of walking, bicycling and other exercise as Active Community Environments (ACEs). A walking- and bicycle-friendly community is also a more livable community where people of all ages and abilities can travel freely. Active Community Environments encourage and accommodate walking and bicycling through their approach to:

- Transportation facilities and services.
- Land-use planning and development.
- Schools.
- Recreation, parks and trails.
- Safety, security and crime prevention.



This section describes what “model” communities look like and how they are planned. Today, few communities exhibit all of the factors described below, but they generally share a least a few of them. Chapter 2 discusses how to make the streets work better for pedestrians and bicyclists.

### Transportation Facilities and Services

There are safe, easy and pleasant places for people of all ages to walk or bicycle using public streets and highways. A balanced system that includes transit, walking, bicycling and automobiles provides people with appropriate transportation choices. Most trips under one mile are made by walking or bicycling. The community:

- Designs new roads to accommodate bicycling and walking.
- Retrofits existing roads to accommodate bicycling and walking.
- Maintains roads and sidewalks for easy, safe use by pedestrians and bicyclists, even during the winter months.
- Makes all routes accessible for people with disabilities.
- Allocates transportation funds so that (a) all projects include the funding needed for bicycling and walking facilities, and (b) an equitable share goes to eliminating pedestrian- and bicycle-related deficiencies in existing roads.
- Lays out new roads using a traditional “grid” pattern to provide more route choices, to reduce trip lengths and to slow motor vehicles.
- Develops a coordinated system of transit, pedestrian and bicycling services and facilities.

*A study in the December 2001 issue of the American Journal of Public Health finds that communities that build bicycling and walking trails, support exercise programs, and provide public areas, such as parks and sidewalks, can boost physical activity levels. Researchers say that providing these facilities could encourage millions of sedentary people to exercise.*

*Author Ross C. Brownson of Saint Louis University in Missouri, said the results indicate that, “parks and sidewalks matter, and could affect obesity rates. We have an epidemic of obesity so we can’t wait for every study to be completed before taking action.”*

*About two-thirds of survey respondents who did at least some physical activity said they exercised on neighborhood streets. Some cited neighborhood obstacles to exercise, including heavy traffic, air pollution from cars and factories, and unattended dogs. Rates of exercise were found to be twice as high among individuals who believed that their neighborhoods were safe.*

*—S. Rostler, Sidewalks, Parks Could Boost U.S. Exercise Rates, New York: Reuters Health*

*“The built environment presents both opportunities for and barriers to participation in physical activity, thereby influencing whether or not we exercise. Research by CDC and others has indicated that two of the main reasons for not exercising are lack of structures or facilities (such as sidewalks and parks) and fears about safety.”*

—R. Jackson, et al., *Healthy Environment: The Impact of the Built Environment on Public Health*, CDC, 2001

**Human Scale:** Facilities are designed for a person walking, such as buildings near the sidewalk, trees, small signs, low lighting, windows, and benches.

Refer to the **Glossary** at the end for an explanation of other terms.

## Land-Use Planning and Development

Development plans and practices focus on creating transit- and pedestrian-oriented communities where the majority of trips are made by a combination of walking, bicycling and transit. Most people walk or bike as part of their routine activities or specifically for recreation and health. Public health impacts and objectives are a regular, routine and guiding consideration in land-use planning decisions. The community:

- Integrates “smart growth” principles in all development programs to:
  - ✓ Increase opportunities for walking, bicycling and transit use.
  - ✓ Efficiently utilize land and existing urban services.
  - ✓ Create transportation options by mixing development and land uses within existing downtowns and new town centers.
  - ✓ Design the urban environment to a more detailed, human scale.
  - ✓ Place buildings facing the street near the sidewalk with parking on the street or behind the buildings.
- Makes positive public health impacts a priority in land-use planning and development decision-making.
- Makes traditional neighborhood development (TND) the standard for residential areas.
- Locates commercial and retail development in downtowns, on main streets, and in new town and neighborhood centers.
- Reduces trip distances.
- Makes walking, bicycling and transit the preferred transportation choices for the majority of trips.

## Schools

Schools are of moderate size and are located in the neighborhood they serve. Most children walk or bike to school. School sites and facilities serve a wide range of communities services and needs. The community:

- Locates schools within walking distance of the student population.
- Provides safe routes to school for students to walk and bike.
- Develops school sites that are pedestrian- and bicycle-oriented.
- Strictly controls the operation of motor vehicles on and near school sites, at bus stops and along school routes.
- Encourages children to bike and walk to school.
- Designs and operates schools as multi-purpose community centers.

## Recreation, Parks and Trails

Basic park and recreation facilities are available in every neighborhood, and most users walk or bike to them. Other recreation facilities are easily accessible by transit. Most children can go to their neighborhood parks by themselves or with their friends. Most organized sports activities take place at parks or school sites located in or near the neighborhoods where the children live. Trail-type facilities are within walking distance of most residential areas. The community:

- Develops neighborhood park and recreation facilities in new subdivisions and in currently underserved residential areas.
- Locates neighborhood park and recreation facilities to be easily and safely accessed by most people, especially children.
- Utilizes smaller sites for youth sport activities (vs. large-scale, regional facilities to which people must drive).
- Utilizes public facilities, such as schools, as multi-purpose facilities, especially for recreation services.
- Develops a system of trails that is readily accessible to most people.

## Safety, Security and Crime Prevention

The community controls motor vehicle traffic so it no longer poses a serious threat to children in neighborhoods or near schools and parks. Motor vehicle operation is strictly regulated, and traffic laws are obeyed by all users. Crashes, injuries and fatalities decline significantly. Crimes of all kinds decline, especially in residential areas. Parents are at ease with the notion of their children playing outside, unsupervised in their neighborhood. Children spend more time outside, playing with other children. The community:

- Ensures that all drivers are careful and responsible.
- Restricts motor vehicle speeds in neighborhoods, near schools and in shopping areas.
- Designs neighborhoods to reduce the threat of crime.
- Improves policing and enforcement to help prevent crime.

---

*“Obesity is second behind tobacco in U.S. health risk factors, contributing to 300,000 deaths a year. Twenty-five percent of Americans are obese, resulting in \$100 billion a year in national health care costs, or one in every \$10 spent, and diabetes, often an obesity complication, represents 25 percent of all Medicare costs.”*

— J.P. Boyle, et al., *Projection of Diabetes Burden Through 2050: Impact of changing demography and disease prevalence in the U.S.* *Diabetes Care*. 24: 1936-1940, 2001

---



## Treating the Patient

Creating local environments that encourage physical activity for all age groups — promoting active living through community design — is one way we can build healthy communities. In most cases, people don't need lavish new facilities in order to achieve higher levels of physical activity. Communities across the country are finding that they can implement simple changes to the physical environment to benefit pedestrians and bicyclists. The next chapter of this guide focuses on some achievable actions that can make a difference.

Some of these changes include retrofitting roadways with sidewalks, curb ramps and features that slow traffic, making it easier and safer to walk. Multiple-use trails, bicycle parking and striped bicycle lanes can be provided to encourage more people to bicycle more often.

Changing existing communities is a complex process involving many agencies, organizations, institutions and the public. A community's infrastructure — streets, parks, schools, residential areas — takes years to develop. So we should expect it to take years to make large-scale adjustments. Think of each small change as part of a time-release treatment that eventually will provide people with widespread opportunities to be more physically active.

And realize that it's unlikely to happen without you. It will take bringing people together to create a new sense of community, and to build the will, capacity and commitment to make the places where we live, work, go to school and play more livable. Consider the wisdom of the motto that has guided progress in Chattanooga, Tennessee:

*"It takes all of us... and it takes forever."*

—As quoted in *Civic Participation and Smart Growth: Transforming Sprawl into a Broader Sense of Citizenship*. Funders' Network for Smart Growth and Livable Communities, Translation Paper Number Four, November 2000.

*"Many people believe that dealing with overweight and obesity is a personal responsibility. To some degree they are right, but it is also a community responsibility. When there are no safe, accessible places for children to play or adults to walk, jog, or ride a bike, that is a community responsibility."*

—David Satcher, Surgeon General, *Call To Action To Prevent and Decrease Overweight and Obesity*, 2001

## How to Improve Conditions for Walking and Bicycling



### What's Your Role?

Many local projects and actions can enhance walking and bicycling. Some of these already may be in place in your neighborhood or community, but you'll no doubt find opportunities to encourage more physical activity through better community design. In the face of so much that needs to be done, you may feel overwhelmed. What can you do?

The good news is that communities are always changing. You are likely to find many plans, projects and other opportunities to make conditions better for walking and bicycling. Perhaps the most difficult decision you will make is where to start and whether you will serve as an organizer, catalyst, leader, local hero, trench worker or a combination of these roles. Recognize from the outset that you can't do it all. To make the changes that will be required, many different people representing diverse disciplines must participate.



*"Public health has got to participate in the planning process. It's vital if we are going to have safer and healthier communities."*

—Richard J. Jackson, MD, MPH, National Center for Environmental Health, CDC

Public health professionals are uniquely positioned to help lead a credible campaign to promote active living through community design.

First, as an *expert*, you can:

- Establish that we have serious national health problems, including obesity and diabetes, related to physical inactivity.
- Confirm that the most effective countermeasures to these problems includes physical activity.
- State that we will not be active unless the design of our communities accommodates and encourages physical activity as a regular, routine part of our daily lives.

### Chapter Two: How to Improve Conditions for Walking and Bicycling

What's Your Role? .....	9
What Needs Doing? .....	11
Community Audit .....	12
More, Better Sidewalks .....	15
Safe & Convenient Crossings ....	17
Bicycle-Friendly Streets .....	19
Trails .....	21
Slow Down Motor Vehicles .....	23
Safe Routes to School .....	25

### Some Actions You Can Take

- ✓ Stress to your patients and the public the importance of daily physical activity and encourage them to walk and bike.
- ✓ Encourage your patients, colleagues and local organizations to help make their communities friendly to walking and bicycling.
- ✓ Incorporate community design issues into patient wellness and lifestyle classes.
- ✓ Start a commuting program at your workplace that promotes walking and bicycling.
- ✓ Encourage community leaders and government staff to solicit the advice of medical professionals about the design of an active community.
- ✓ Make presentations on active living through community design to local schools, senior centers, civic groups (Chamber, Rotary, etc.) and committees (transportation, budget, etc.).
- ✓ Write a guest editorial about physical activity, health and community design for your local paper.
- ✓ Ask people running for elected office to commit to making healthy community design a priority.

Second, as an **advocate**, you can:

- Serve as a good role model for a physically active lifestyle.
- Help develop the understanding and support needed to define new goals and objectives for the planning, design and management of physically active communities.
- Inspire, empower and encourage other community groups to work together to achieve these goals and objectives.

Third, as a **change agent**, you can:

- Help to identify and implement actions needed to create environments that promote physical activity.
- Suggest using existing resources in new areas and on new priorities to achieve the desired outcomes.
- Direct the concern of professional medical organizations to supporting active community design.

Fourth, as a **monitor**, you can:

- Be vigilant for opportunities to exert influence.
- Marshal resources to effect change.
- Provide continuity to the process of change.
- Assess and report on progress made toward achieving the goals and objectives.

Perhaps the most important job a public health professional can do is to make public health concerns and their connection to physically active communities prominent. This is your justification for being interested, for being involved, and for insisting that changes must be made. This is what lends legitimacy to your questions, your presentations, your proposals and your agenda. When community leaders, officials and decision-makers understand that communities friendly to walking and bicycling are the key to healthy people and act accordingly, you will have succeeded in your mission.

*“People in other aspects of community planning are very happy to have people from the health arena at the table. They’re thinking that it’s not just them who are out there arguing for a bicycle lane – there are actually people who think that it’s important from a health perspective. It gives them added ammunition to advocate for a healthier community....”*

*“Stepping out of our realm, which tends to be disease focused and individual risk factor focused, we actually have something to offer the broader community. And people do listen to us. They like having us at the table.”*

–Katrina Hedberg, MD, MPH, Deputy State Epidemiologist, State of Oregon Health Division

# What Needs Doing?

It's safe to say that, as a public health practitioner, you probably won't be designing intersections, pouring concrete for new sidewalks or operating a street sweeper. But it is useful to know what transportation engineers and public works departments can do to make conditions better for pedestrians and bicyclists.

This chapter describes actions these professionals can take — and those you can ask for — that will help get more people walking and bicycling. To make your task easier, you may want to present your local transportation engineer and public works director with a copy of this guide.

There are hundreds of projects that can encourage people to walk and bike more. Here's a list of seven such projects that are being implemented in communities across the country:

1. **Community Audit**
2. **More, Better Sidewalks**
3. **Safe and Convenient Crossings**
4. **Bicycle-Friendly Streets**
5. **Trails**
6. **Slow Down Motor Vehicles**
7. **Safe Routes to School**

If you can tackle some of these items, you will have a good foundation from which to create a community friendly to bicycling and walking. In the process, you will gain insight into the processes of community design, planning and funding.



---

*“The health infrastructure is every bit as important in a livable community as roads, paths, sewer and water. We have to think of the total environment that people live in. My friends who are in the health arena have been too bashful in demanding a place at the table.”*

—Congressman  
Earl Blumenauer, Oregon,  
Third District

---



---

*“The public health community is beginning to return to its roots, once again partnering with architects, planners and engineers to better understand how to build healthier communities and lifestyles.”*

—William L. Roper, MD,  
MPH, Dean, School of  
Public Health, The  
University of North  
Carolina at Chapel Hill

---

## 1 Conduct a Community Audit

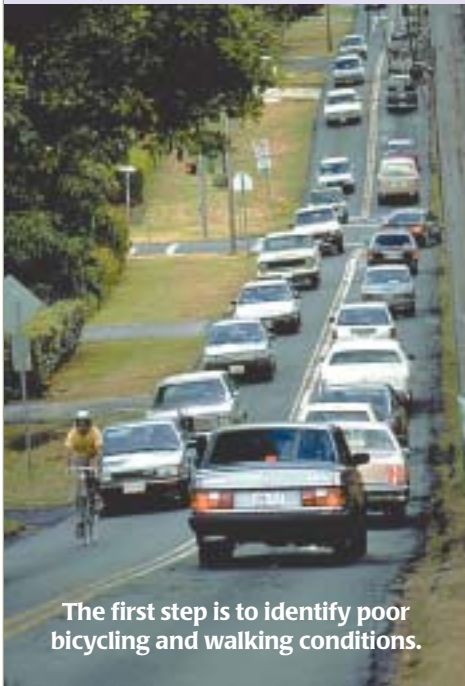

The first step is to identify poor bicycling and walking conditions.



### Problem

How walking- and bicycle-friendly is your community? You know that walking and bicycling conditions need improving, but you have difficulty gauging the extent of the problem, much less recommending where specific improvements are needed.

Transportation departments thrive on data, especially when it comes to planning future projects. Unfortunately, they often lack a complete, current inventory of walking and bicycling facilities. Road maintenance departments are more apt to respond to specific requests, but they may not be paying close attention to every sidewalk and bikeway. Public officials may sympathize with goals to increase walking and bicycling, but they need information regarding what needs to be done and who supports these actions. The residents of a neighborhood may not know what to ask for.

### Solution

The first step in fixing something that is broken is to identify the problem. If few people are bicycling on a street, find out why. If pedestrians have trouble crossing at an intersection, look for causes. Review and assess as many of the streets and highways in your community as possible to identify where there are barriers to walking or bicycling.

Start with the downtown and schools. As time allows, expand to commercial centers, around parks, residential subdivisions, and other places where people are likely to walk and bike.

Look at both existing data, if any, and the facilities themselves. Your transportation department already may have some kind of inventory of sidewalks, bike lanes and perhaps even curb ramps. The police or a safety committee may have crash locations listed. But remember: crash data show where people got hit but not necessarily where they can't cross the street.

A good way to discover what people experience while walking or bicycling, and what might be preventing them from doing so, is to conduct an informal inventory or "audit" of existing conditions throughout your community. Not by car, but by foot (or wheelchair) and bicycle. The immediate physical environment has a profound effect on the level of comfort pedestrians and bicyclists experience. Many of the problems you will discover are small, subtle and not discernible from a motor vehicle.

For a quick test audit, pick and try a route that has a purpose. Walk or bicycle from your home to the nearest school, shopping center, office building or local park.



**Pedestrian Audit**

- Are sidewalks continuous along the entire route? If not, where are they interrupted?
- Are the sidewalks in good repair, or are there broken sections that would impede travel when using a wheelchair, walker or baby stroller?
- Are there crosswalks and pedestrian signals to help people cross busy streets and intersections?
- Can slow-moving pedestrians get across the street in the time allowed by the signal?
- Do drivers yield to pedestrians at driveways and crosswalks?
- Are any utility poles, signs, vending machines, dumpsters, shrubbery or overhead obstacles blocking the sidewalk?
- Are there trees along the street to provide shade and separation from traffic?
- Do the street, adjacent buildings and landscaping provide a pleasant visual environment?
- Are there frequent benches or other places to sit and rest?
- Are storefronts attractive and inviting?
- Is there other pedestrian activity along the way?
- Was the walk enjoyable? Why or why not?
- Would you repeat this walking trip again? Why or why not?

**Bicycle Audit**

- Am I able to find a comfortable route to my destination?
- Is secure bicycle parking available at my destination?
- Is there sufficient operating width along the route? (Refer to standards at right.)
- Are alternate, quieter routes to my destination available?
- Is the roadway surface in good repair?
- Do traffic signals detect my presence?
- Are drivers friendly and tolerant toward bicyclists?
- Is there a place to clean up and change clothes at work or school?
- Did I enjoy my bicycling experience? Why or why not?
- Would I repeat this bicycle trip again? Why or why not?

**Standard Sidewalk Dimensions**

**Width** (varies by type of street, larger number preferred):

- Local = 5 to 6 ft
- Commercial area outside downtown = 8 to 10 ft
- Downtown = 10 to 12 ft

**Horizontal Clear Space** = 3 to 5 ft

**Vertical Clear Space** = 7 to 8 ft

**Planting Strip** (buffer zone)

Between sidewalk and street = 4 to 8 ft

**Surface vertical change** (abrupt, such as sidewalk cracks) = 1/4 in. maximum

**Surface gap** = 1/2 in. maximum

**Slope** in direction of travel = 5 percent maximum (1:20)

**Cross-slope** across direction of travel = 2 percent maximum (1:50)

**Standard Bikeway Width**

(One-way travel; recommended width depends on motor vehicle speed and volume.)

**Bike Lane** = 4 to 6 ft

**Paved Shoulder** = 4 to 6 ft

**Wide Curb Lane** (shared by cars and bikes)  $\geq$  14 to 16 ft

“...organizations will have to reach beyond their comfort zone. For example, many mid-life and older people are not likely to walk if they live in neighborhoods that have no sidewalks or are dangerous. Public health professionals will have to learn about local transportation planning and how to work with elected officials to encourage exercise-friendly neighborhoods.”

“Identify barriers to walking for adults age 50 and older, determine why these barriers exist, and develop specific recommendations for how to overcome and avoid them.”

—*The National Blueprint: Increasing Physical Activity Among Adults Aged 50 and Older*, The Robert Wood Johnson Foundation, 2001

Carry along a camera and make a photographic record of things that impede your progress or interfere with reaching your destination. Photos will come in handy later for presentations.

During your pedestrian and bicycle audits, ask yourself the questions on the list on the previous page and make note of your findings.

Organize and summarize your findings to highlight deficient areas for transportation planners, public works officials, budget committees and the public.

### Considerations

Think of a pedestrian or bicycle trip as a chain of many small but essential links. For pedestrians, it may be a segment of sidewalk here, a curb ramp there, and a multitude of driveway and street crossings. Each link needs to be in place and functional to provide pedestrians and bicyclists with an easy, safe travel opportunity. If there is a missing link in the chain, a person may be inconvenienced, delayed, put at risk or discouraged from attempting another walking or cycling trip in the future.

Small, local improvements are usually much easier to implement than changes to an entire network. Because spot improvements tend to be finite, discrete and limited in scope, it may be easier initially to get support for them than it would be for more comprehensive projects.

Collecting, organizing and communicating data takes time but requires few material costs. City staff, especially summer interns, may be of help. A citizen bicycle and pedestrian advisory committee or neighborhood association also may want to participate, or a local school might want to take on the work as a class project.

“Three out of five disabled and elderly people [in Houston Texas] do not have sidewalks between their residences and the nearest bus stop.”

—J. Gilderbloom and J. Markham. *Housing Quality Among the Elderly: A Decade of Changes*. Aging Human Development. 1998: 46(1).



## 2 Build More, Better Sidewalks

### Problem

Your audit may have revealed missing or inadequate sections of sidewalk. Additionally, some or all of the following problems may have been noted: narrow or obstructed travelway, broken pavement, low overhanging signs or branches, lack of accessible ramps, puddles, debris, and lack of a buffer between the sidewalk and traffic.

### Solution

A continuous network of good sidewalks is vital for encouraging more people to walk. The Americans with Disabilities Act (ADA) requires an accessible pedestrian route along all public rights-of-way. Transportation projects that use federal funds must consider bicycle and pedestrian needs.

Add sidewalks where they are missing on both sides of major streets and in downtowns, and on at least one side (preferably both sides) of local streets. Add paved shoulders on rural roads. Where sidewalks are in poor condition or littered with debris, find out who is responsible for maintenance and request that they follow through with their obligations.

Look for opportunities to connect building entrances with sidewalks. When retrofitting places that do not have a continuous sidewalk system, the streets near schools, parks, public buildings and transit stops should have the highest priority.

The preferred dimensions for pedestrian facilities are listed under Community Audit. Use ADA requirements as the minimum design specifications on all streets and highways.

### Considerations

**Width** — The Institute of Traffic Engineers (ITE) recommends a minimum width of 5 feet for a sidewalk or walkway. This allows two people to walk comfortably side by side, or to pass one another. Where higher concentrations of pedestrians are



The latest ADA guidelines by the U.S. Access Board are at [www.access-board.gov](http://www.access-board.gov)

### Sidewalk Width – More is Better for Pedestrian Activity

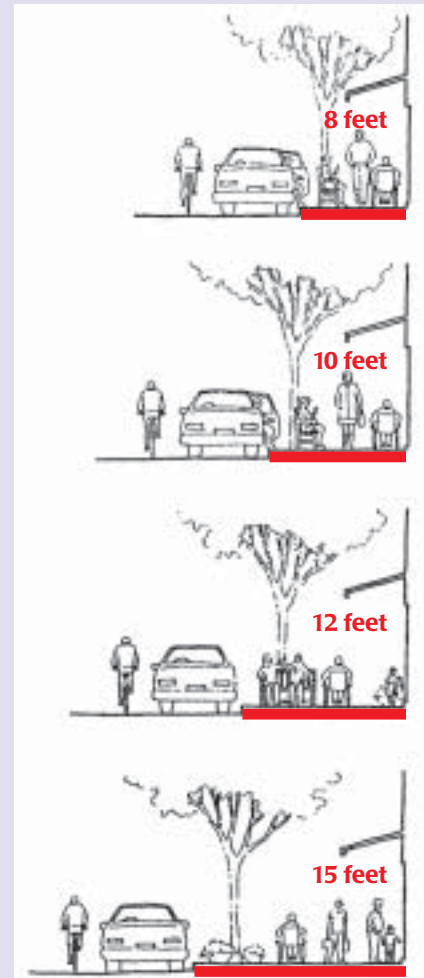

The preferred sidewalk width in a downtown or other activity area is 12 feet, at least 6 feet of which should be clear of obstructions. This width allows two pedestrians to walk side by side, or to pass each other comfortably. It generally provides enough width for window shopping, some street furniture (benches, lamps, etc.) and places for people to stop. More width is desirable to accommodate bus shelters, sidewalk cafés and other outdoor retail. In a pinch, 8 feet is acceptable. Outside of the downtown, sidewalks should be at least 5 feet wide.

### Some land uses pedestrians like:

- + Storefronts
- + Porches
- + Walls with windows
- + Landscaped yards

### Some land uses pedestrians don't like:

- Garage doors
- Blank walls
- Open parking lots
- Unbuffered parking structures
- Too many driveways
- Open service areas

expected (downtown areas, schools, transit stops) the sidewalks should be wider.

**Maintenance** — Adopt policies for state and local transportation agencies for maintenance of sidewalks modeled on maintenance of the adjacent street or highway. Give sidewalk snow removal equal or greater priority for pedestrians as for motor vehicles, and assign responsibility for sidewalk snow removal to the same public agency or organization responsible for snow removal on the adjacent roadway.

**Buffer** — A buffer zone between the street and sidewalk further separates pedestrians from the street and provides a more comfortable walking environment. A buffer zone might be a grass strip between 4 and 8 feet in width, preferably with trees. It also could be a paved extension of the sidewalk or parking bays. Wider sidewalks should be installed around schools, transit stops, downtown areas or anywhere high concentrations of pedestrians exist.

**Land Use** — A good pedestrian environment is much more than a clear sidewalk and separation from traffic, although those things are important. Without attractive buildings and a mix of connected uses, even the best street and sidewalk design will not be successful in attracting pedestrians.

A continuous row of buildings with windows and entrances facing the street creates an interesting and secure walking environment. Blank walls and empty lots are boring and unfriendly. People often will walk longer distances if their route takes them by attractive buildings.



Beyond the buildings, it's land use that really determines walkability. The most active walking areas *allow* and *encourage* a rich mix of land uses: shops, restaurants, offices, residences, public buildings (post office, library, city hall), entertainment, public spaces (parks and plazas) and even some light industry.

**This street has many features that attract pedestrians:**

- Wide sidewalk
- Planting strip with trees
- Mix of uses
- Sidewalk-oriented business

### 3 Create Safe and Convenient Crossings

#### Problem

Most people begin their walks or bicycle rides within a residential area with lower traffic volumes and speeds. But if their walk or ride is of any appreciable duration, they soon will reach a busier street. Major streets may be over 100 feet wide, and automobile speeds often reach or exceed 45 to 50 mph (even when posted for less). Highly visible, marked crosswalks are often absent or they may be too few and far between.

Crossing such a busy street may be too great a challenge for many children, seniors or people with disabilities. For them, the trip may be made impossible because they “can’t get there from here.” Intersections with wide, highway-style streets often have high pedestrian crash rates.

Even when pedestrians are walking parallel to a major street, they can be at risk when crossing side streets and driveways. A common crash type at intersections involves pedestrians struck by right-turning vehicles. The wide curb radius (see next page) often used in street design encourages motorists to take corners at higher speeds.



*“Crosswalks are the critical links in a connected pedestrian network, and crossing the street is by far the most dangerous aspect of being a pedestrian. On average, a pedestrian is killed or injured by an automobile every six minutes in the United States, and nearly three-quarters of these pedestrian-automobile collisions occur when pedestrians are attempting to cross the roadway.*

*[FHWA, 1997]”*

—E. Vanderslice, President, America Walks. *Why Did the Pedestrian Cross the Road?* 2001.

*“Although Americans make fewer than 6 percent of their trips on foot, 13 percent of all traffic fatalities occur among pedestrians; of the pedestrian deaths for which information is recorded, almost 60 percent occurred in places where no crosswalk was available.”*

—Surface Transportation Policy Project. *Mean Streets 2000: A Transportation and Quality of Life Campaign Report.* 2001

Intersection signals can work for or against the pedestrian and the bicyclist. First, many signals only detect motor vehicles. If forced to wait a long time for a green light or a walk signal, some cyclists and pedestrians will ignore the signals and start across when a gap in traffic occurs. Second, the signals may be visible only to drivers in the travel lanes, and not to pedestrians or cyclists. Finally, the signal time for crossing may be too short to allow pedestrians and even some bicyclists to get to the other side.

Oregon's Land Use Transportation Air Quality (LUTRAQ) study found that people who lived in pedestrian-friendly neighborhoods made nearly four times as many walking and bicycling trips as people who lived in neighborhoods with poor pedestrian environments.

**A smaller corner radius** shortens crossing distance and slows down turning cars.

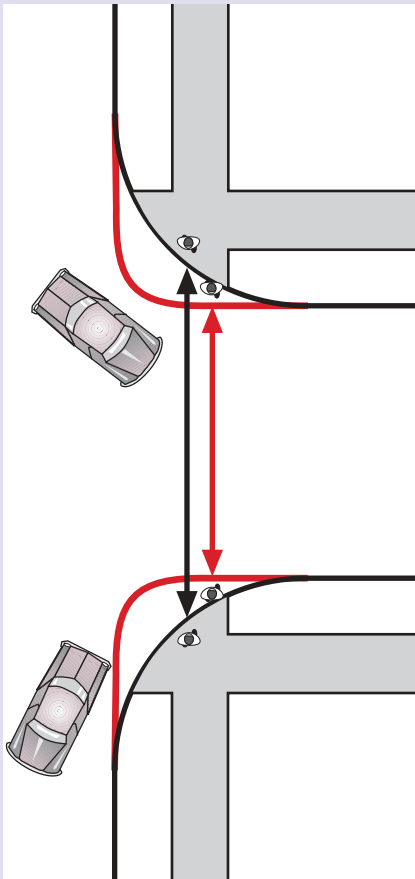

## Solution

Traffic engineers have many techniques to design and operate intersections that provide for easy, safe movement by pedestrians and bicyclists. Ask them to:

- Shorten crossing distances by using small corner radii where truck traffic is not a concern (see diagram at left), curb extensions where parking is allowed on local streets, and pedestrian refuges or median islands in the center of multi-lane roadways.
- Provide curb (wheelchair) ramps at all locations where pedestrians must change grade between a sidewalk or pathway and the street.
- Restrict curb parking at specific crossing points to provide greater visibility for pedestrians and drivers.
- Employ traffic-calming measures that will slow motor vehicles (see section on Slow Down Motor Vehicles).
- Increase the length of time for pedestrians to cross at signals.
- Use highly visible, marked crosswalks at all intersections where sidewalks or paved shoulders are provided.
- In areas where there are mixed land uses or transit service that generate pedestrian activity, provide improved crossing opportunities on multi-lane roadways every 400 feet. In other areas, provide improved crossing opportunities at least every 1000 feet.
- Require drivers to STOP, not just YIELD, for pedestrians in a crosswalk.
- Use supplemental identification devices (signs, beacons) to draw drivers' attention to the presence of a marked crosswalk.
- Use a detector that is sensitive to bicycles at signals.

## Considerations

At intersections where you expect more pedestrians, consider reconstructing the curb to require a tighter turn (top car in diagram at left). This has the multiple advantages of slowing motorists who are turning, improving the sight distance between the approaching motorist and the pedestrian, reducing the distance a pedestrian must travel across the street, increasing the waiting area available to pedestrians, and simplifying curb ramp design.

Shorter signal cycle lengths and longer pedestrian crossing intervals will encourage pedestrians and cyclists to view crossings of busy arterials not as barriers, but as part of a system that allows them great mobility.

## 4 Make Streets More Bicycle Friendly

### Problem

Surveys indicate more people would bicycle more often if they had safer places to ride. But so many of today's streets are so crowded with fast motor vehicle traffic that nothing is left for the slower cyclist. A lack of adequate operating space along a roadway can make bicyclists and motorists feel uncomfortable or even unsafe.

### Solution

Provide appropriate on-road facilities and adequate operating space for bicyclists:

- Bike lanes and wide curb lanes in urban and suburban locations.
- Paved shoulders along rural highways.
- Bicycle access to/from transit stops.
- Secure bicycle parking.
- Proper maintenance, with regular sweeping and repairs.

### Considerations

On fast or busy streets, striped bike lanes or paved shoulders are desired. On major streets with slow traffic, such as downtown main streets, both bicycles and motor vehicles may be accommodated in a wide outside lane (14 to 16 feet). On low-speed, residential streets, cyclists can comfortably share a travel lane (12 feet) with motorists.

**Bike Lanes** — Bike lanes are a popular way of providing bicycle riders with a designated place to ride. As an added benefit, the installation of bike lanes can make streets more pedestrian-friendly by providing more of a buffer from passing motor vehicles.

Look at each potential route for the available space to add bicycle lanes. Striping lanes will require 4 to 5 feet of lane width in each direction, or between 8 and 10 feet total. This can be accomplished in several ways:

- Narrowing the motor vehicle travel lanes;
- Eliminating through lanes or turn lanes;
- Eliminating a parking lane; or
- Widening the pavement.

Bike lanes along busy streets are a good strategy for increasing the level of bicycling among casual cyclists. They should be a standard feature for new roads and a required component when appropriate roadways are resurfaced or otherwise upgraded.



### What are bike lanes?

- Intended for preferential or exclusive use of bicyclists.
- Designated by signing, striping and pavement markings.
- One-way in the direction of traffic flow.
- On the roadway.
- Provide for more predictable movements of motorists and bicyclists.



### **Shoulders Have Many Benefits**

(most also apply to bike lanes)

- Greater separation from traffic for bicycles.
- A place for pedestrians and wheelchairs in places with no sidewalks.
- Space for normal and evasive vehicle maneuvers.
- Recovery area to regain control of a vehicle.
- Space for disabled vehicles and emergency equipment.
- Better sight distance for drivers.
- Reduced passing conflicts between motor vehicles and bicyclists and pedestrians.
- Pedestrians more visible to motorists.
- Storm water discharge farther from travel lanes, reducing hydroplaning, splash and spray.
- Less dust and debris kicked up by vehicles.
- Structural support to the pavement.

**Paved Shoulders** — Paved shoulders on rural roads have many safety benefits for all users and reduce roadway maintenance costs. If intended for bicycle use, they should be at least 4 feet wide, and 6 feet is ideal.

Rural highways and county roads provide good opportunities for long-distance touring and shorter recreational rides. Closer to cities, these roads serve as commuter routes into the urban area from outlying residential areas.

**Bicycle Parking** — Secure bicycle parking can help encourage more cycling. Many bicycle journeys end somewhere other than at the bicyclist's home, which may mean leaning bicycles against store windows or trees or locking them to sign posts or parking meters.

Bicycle parking can be provided using three basic approaches. For short-term parking, bicycle racks to which a bike can be locked with a cable or U-lock are usually the choice. At sites that require long-term parking, such as at a transit station, lockers (stand-alone enclosures designed to hold one bicycle per unit) are often the choice. For long-term parking for a number of regular users, secure enclosures called bicycle lock-ups (site-built secure enclosures that hold one or more bicycles) may be the answer.

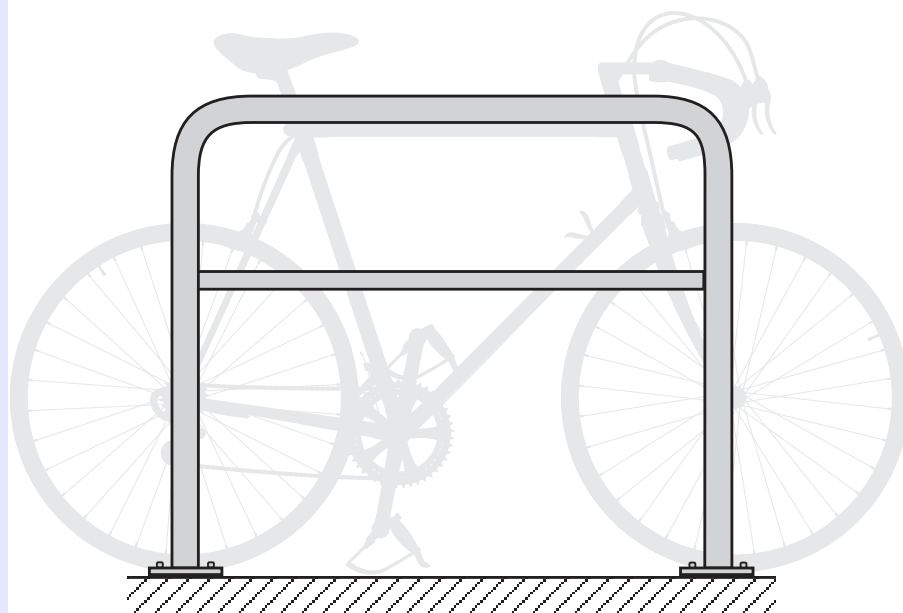



## 5 Build More Trails

### Problem

Many communities lack paths that are separate from the roads and free from motorized traffic. This type of facility is very popular with users of all ages and abilities. The Burke-Gilman Trail in Seattle, Washington, the Eliza Furnace Trail in Pittsburgh, Pennsylvania, and the Riverfront Trail in Missoula, Montana, are three examples of the hundreds of off-road, urban paths that are often jammed with users.

### Solution

Develop trail facilities along natural corridors (such as river and stream valleys), utility easements, canals and parkways, abandoned rail lines and wherever else they fit in. Provide shorter connections between trails and neighborhoods, parks, recreation facilities, libraries and commercial and work sites.

Expanding a trail system can bring exercise and self-powered transportation opportunities to a greater number of potential users and can help spread use over a larger system, which may help reduce the growing congestion on existing shared-use trails.

### Considerations

Off-road paths or trails can be an important part of an inter-connecting network of bicycle and pedestrian facilities. They complement rather than substitute for a good system of on-street facilities. Some users will walk or cycle on the trails for exercise; others will use them for errands, or to travel to school or work. These more utilitarian uses succeed only if the trails are part of a network of facilities that take people to desired destinations.

While abandoned rail corridors seem to capture most of the attention these days, do not overlook other potential corridors, such as utility easements and waterway corridors. In addition to uses for recreation and utilitarian travel, these trails can create linear parks and preserve transportation corridors. An example is the Capital Crescent Trail, which runs through suburban Maryland and the District of Columbia. This trail has preserved a corridor for potential future light-rail use that could never be pieced together again if it had been lost to development.

The American Association of State Highway and Transportation Officials (AASHTO) recommends that shared-use paths be at least 10 feet wide to accommodate multiple users traveling in both directions. Trails with heavier use, or those attracting large numbers of in-line skaters, may need to be wider. In addition to the width of the surfaced portion of the path, at least two feet of clear space to either side of the trail is recommended so that users can avoid obstacles such as signs, shrubs and walls.

---

*“As an exercise physiologist and the former Director of the Shepard College Wellness Center, I see the West Virginia Rail Trail system as a way to enjoy the outdoors and exercise at the same time.”*

—Donna Printz, Chair, West Virginia Rails-to-Trails Council

---



Successful paths have:

- Continuous separation from traffic, such as along a river or greenbelt.
- Few street or driveway crossings that would cause conflicts. Paths adjacent to roadways are generally not recommended.
- Convenient and safe access to the local road network.
- Connection to land uses, such as shopping malls, downtown, schools and other community destinations.
- Well-designed street crossings, with measures such as bike- and pedestrian-activated signals, median refuges, and warning signs for both motor vehicles and path users.
- Shorter trip lengths than the road network, with connections between dead-end streets or cul-de-sacs, or as shortcuts through open spaces.
- Scenic qualities, offering an aesthetic experience that attracts cyclists and pedestrians.
- Visibility from nearby buildings and streets for safety.
- Good design, including adequate width and sight distance, good drainage and moderate slopes.
- Proper maintenance, with regular sweeping and repairs.
- Clear destination and directional signing.



Trail crossing of highway with signal, median and high-visibility crosswalk

## 6 Slow Down Motor Vehicles

### Problem

Speeding motor vehicles are probably the most common concern of walkers and cyclists on both local and major streets.

The wide residential streets typical of many new subdivisions encourage speeding. As streets get wider, drivers instinctively accelerate. As speeds go up, the risks to pedestrians and cyclists increase dramatically.

On major streets (arterials and collectors) an emphasis on mobility has resulted in speeds higher than appropriate for some of the areas the streets pass through (e.g., school zones, residential areas and shopping districts).

### Solution

Limit motor vehicle speeds on streets in urban and suburban areas to levels compatible with adjacent land uses and with bicycling and walking (i.e., 35 mph or less on major streets and 20 mph or less on neighborhood or residential streets).

Reduce the typical design speeds and roadway widths in neighborhood and residential areas. In other words, change the design so people will drive at the posted speed limit.

Use traffic-calming measures to help control driver behavior and motor vehicle speeds, especially in residential, school, park and shopping areas. Although traffic calming is often a retrofit to deal with identified problems, it is also an important aspect of new construction to prevent problems from occurring. Your community already may have a traffic-calming program. If so, ask about its effectiveness and what can be done to improve it.

### Considerations

You can reduce traffic speed and volume through a variety of measures:

- Change the horizontal alignment of the roadway: chicanes (short jogs in the street), roundabouts, traffic circles, etc.
- Change the vertical alignment of the roadway (raised intersection, speed hump, speed table, raised crosswalk, etc.).



Speed hump with median island

*“Traffic calming is a set of techniques of street design. It involves a variety of small modifications to street geometry and dimensions to accommodate the automobile and to give the pedestrian psychological precedence.... it is far easier to get people to act differently by redesigning their environment rather than by persuading them with exhortation and even penalties.”*

—D. Sucher. *City Comforts*. 1995

According to the Surface Transportation Policy Project's 1997 *Mean Streets* report, more than half of all pedestrian fatalities occur on roadways that run through residential neighborhoods. And a 1998 study of 20,000 accidents over a 20-year period in Longmont, Colorado, found a direct correlation between street width and crash rates. The safest streets were narrow, 24-foot wide streets. As streets got wider, the number of crashes per mile increased.

Refer to the **Glossary** at the end for terms such as *curb extension* and *smart growth*.

- Narrow the travel lane or roadway in either real or perceived ways (curb extension, curb radius reduction, on-street parking, pedestrian refuge island, landscaping, etc.).
- Regulate and enforce movements (signed turning restrictions, truck restrictions, photo radar, etc.).
- Reduce the need to travel (smart growth land-use planning, traditional neighborhood development, travel demand management).
- Can be applied in appropriate ways to both residential and commercial streets and highways.

Traffic calming can yield some significant safety benefits. For example, adding small traffic circles at neighborhood intersections resulted in a 77 percent reduction in crashes in Seattle, Washington, and a 58 percent reduction in crashes in Portland, Oregon. Curb bulbs (extensions) in Vancouver, British Columbia, reduced crashes by 75 percent, and narrowing streets in the same city reduced crashes by 74 percent.

Successful traffic-calming projects:

- Employ a combination of measures that will have a much greater effect than just one or two measures.
- Look at an entire neighborhood or area rather than one location.

- Include public involvement to determine neighborhood goals, identify concerns and generate support.
- Include a complete package of design and landscaping features that improve neighborhood aesthetics and livability.



Roundabout entrance

Crosswalk on speed table with median



## 7 Develop Safe Routes to School



### Problem

Fewer and fewer children walk or bicycle to school. Even children who live within a mile of school — easy walking distance — are often transported by bus or car. In some cases, children are not encouraged to walk or bicycle because their parents fear they will be endangered by traffic or crime. In other instances, some school administrators actively discourage bicycling and walking to school, preferring to simply consign all children to a yellow bus.

Ironically, these actions can increase the danger to children living in the vicinity of a school because of the increase in motor vehicle traffic. Harried parents may, at times, forget the health and safety of the neighborhood children in their rush to get everyone to work and school on time.

### Solution

A growing number of communities have begun programs loosely grouped under the title of Safe Routes to Schools. School officials, parents, and local and national organizations are starting to work together to get more kids walking and cycling for daily, short-distance trips.

In a typical Safe Routes to School program, walking routes with high safety rankings are identified using a list of criteria, including:

- Availability of sidewalks;
- Low traffic speeds and volumes;
- The number of street crossings required;
- The area through which the route passes (residential, commercial, industrial);
- Sight distances and visibility;

*“Every child needs to move, but not every child likes sports. Some don’t welcome yet another rules-dominated, adult-run activity. Some lack athletic talent. Some have parents who can’t afford the fees or can’t chauffeur them to practice. But sports or no sports, every child still needs to move — and it’s a need our world conspires to deny. From schools with shrinking recess times to streets without sidewalks to homes filled with mesmerizing screens, today’s environment encourages immobility.”*

*—Kids on the move: Children don’t need to play team sports to stay active and fit, The Providence Journal, Dec. 17, 2000*

**Kids Walk-to-School** is a program that aims to get children to walk and bicycle to and from school in groups accompanied by adults. This gives kids a chance to be more physically active, to practice safe pedestrian skills and to learn more about their environment. For a detailed manual on the program, see [www.cdc.gov/nccdphp/dnpa/kidswalk/pdf/kidswalk.pdf](http://www.cdc.gov/nccdphp/dnpa/kidswalk/pdf/kidswalk.pdf).

- Availability of pedestrian walk signals at intersections; and
- Availability of crossing guards at busy intersections in the school zone.

All of these items are factored together, and the safest routes are established. Parents are supplied with a map indicating suggested routes and are encouraged to have their children walk to school. A note about physical exercise accompanies the map.

More proactive communities take this a step further and fix problems that have been identified by:

- Connecting school sites to the neighborhoods they serve with sidewalks, safe street crossings, bicycle-friendly streets and trails.
- Making all school entrances directly accessible by pedestrians.
- Providing good bicycle parking at all schools in a safe, secure and convenient location.
- Planning school bus routes, and pick-up and drop-off points, to minimize conflicts with pedestrians and bicyclists.
- Reducing parking facilities at schools for personnel and students and locating parking to minimize conflicts with pedestrians and bicyclists.
- Using traffic-calming techniques and other forms of street design to limit motor vehicle speeds and volumes near school sites.
- Implementing aggressive traffic enforcement to control motor vehicle speeds on school routes.

### Considerations

One way to address parents' fears of traffic and crime is the walking school bus. An adult — often a parent of a neighborhood child — begins walking the established route to school at a specified time each day, collecting children along the way. The adult's primary responsibility is to watch for cars at intersections and other crossings. Another adult meets the group at a location near the school each afternoon and repeats the process in reverse. (A side benefit of this program is that a couple of adults get their daily exercise as well.)

# Chapter Three

How to

## Get it Funded



Eventually, someone will ask the question, “How are we going to pay for it?” Funds are ultimately limited, and competition for them can be fierce. Pedestrian and bicycle projects traditionally have been low on the priority list of both elected officials and public agencies, although this has changed somewhat in the last decade thanks to growing public demand and new federal funding programs.

It is useful to keep in mind just how much money is being spent on transportation projects. In 1993, transportation spending in the U.S. for road construction, maintenance and operations exceeded 88 billion dollars, according to a federal highway cost study. However, only a tiny fraction of this was spent on pedestrian and bicycle facilities — too small to even report on separately in the study.

Although some of these funds are restricted to specific purposes, the majority are flexible and can be used for pedestrian and bicycle improvements. There’s a real opportunity to direct a greater share of these funds to long-overlooked improvements in walking and bicycling facilities.

This chapter will give you a basic understanding of funding processes. With this knowledge you can better advocate for the use of a greater portion of these funds for bicycling and walking facilities. Although it is not always easy, many more projects are getting built thanks to good planning, commitment and community support. Indeed, a lack of funds is rarely the real hurdle to be overcome; instead, it is a lack of commitment to making it happen.

---

*“Can anybody remember when the times were not hard and money not scarce?”*

—Ralph Waldo Emerson (1803-82)

---

### **Chapter Three: How to Get it Funded**

Develop a Strategy .....	28
<i>Maintenance .....</i>	<i>28</i>
<i>Capital Improvements .....</i>	<i>29</i>
<i>Private Development .....</i>	<i>30</i>
Identify Funding Sources ....	31
<i>State and Local Road Projects..</i>	<i>31</i>
<i>Federal Programs .....</i>	<i>31</i>
<i>Local Revenue Sources .....</i>	<i>37</i>
<i>Private Donations .....</i>	<i>38</i>
Follow Through with the Project .....	39
Summary .....	39

## Develop a Strategy

Project funding in different communities can be quite different and may appear mysterious to most citizens and government officials. Typically, numerous agencies — at federal, state, regional and local levels — control portions of available funds for specific purposes, and they all have different processes for determining what gets funded.

Transportation funding sources, particularly those involving federal and state sources, may be planned years in advance. Some state and most local sources are distributed annually, whereas private sources can have more flexibility. A successful funding strategy requires familiarity with the local process. You also need to plan ahead and remain alert to opportunities.

It may help to understand that most public road projects are conducted either through maintenance or capital improvements programs, or by private developers as a condition of approval for their development. These areas are funded separately, and your approach to getting projects done should take that into account.

### Maintenance

Crosswalk installation, bike lane striping, sidewalk repair, and minor construction, such as curb ramps, can often be done as maintenance projects. Few maintenance departments have an adequate budget for everything they need to do, so you will have to develop a strong base of support for your project request to get it implemented this way. In cases where property owners are responsible for adjacent sidewalks, you might need to be persistent to get their attention (some municipalities rigorously enforce maintenance codes when violations are brought to their attention).

Here's where planning ahead comes in. If you have a scheme for a logical series of improvements that can be spread over time, it will be easier to get the maintenance department to budget for the improvements than if you come to them with random projects. Make a list grouped by street or travel corridor and roughly ranked by priority. Show how each project will eliminate a hazard or solve a problem.

It is also a big plus if you can piggyback small bicycle and pedestrian improvements on larger projects, such as street repaving or expansion. The additional cost may be incidental and more easily included in a major project. You might want to look at your area's capital improvement program to see if any projects are planned for streets on which bicycle or pedestrian improvements are needed.

*"Keep your head up, your eyes and ears open, and talk to everyone!"*

—Oregon Main Street Handbook, 1999

Three project origins:

- ✓ Maintenance
- ✓ Capital improvements
- ✓ Private Development



Most cities have many miles of potential sidewalk infill projects.



## Capital Improvements

Capital improvement projects, such as rebuilding a road or constructing a long segment of new sidewalk, are more expensive and more formal than maintenance projects. Before funding is even considered, the project may need to be evaluated, studied, conceptually designed and scoped (where project components and costs are identified). Depending on the agency, there may be some public involvement, possibly including citizen committees. Advocates should be involved in this early planning to ensure that pedestrian and bicycle needs are given adequate attention.

Things can get quickly off track, so keep your head up, your eyes and ears open and talk to everyone. Establish and maintain close contact with state and local transportation representatives so that any projects that might affect your neighborhood or community are known and discussed well ahead of formal scoping.

There are several planning steps that any community can take to define and express its needs and desires in a way that improves your chances for success:

- Create a written and visual plan of what needs to be done.
- Get your vision and projects included in formal transportation plans and programs that are updated periodically (see sidebar).
- Help get supporting development codes and standards adopted.

Project selection and commitment of funds usually occur at a formal hearing, although much of the groundwork is done long before. If your project is not selected the first time around, don't despair. Most project lists, although they may be modified annually, span several years and include long-term projects that tie up much of the funding. You may need to organize more support to rise to the top.

The communities that are best positioned to take advantage of funding and other opportunities are those that have done their homework. This means creating a dynamic and very public vision of what the community wants to be — and committing to that vision.

It also means continuously promoting the vision to decision-makers at all levels. Major projects may be years in the making, so a community needs to make the effort to keep locally important projects alive. The projects that have long-term champions are the ones that get implemented. So it is important that groundwork be laid to ensure your project has strong community and agency support from inception through completion.

### How the Federal Transportation Money Flows

#### Long-Range Transportation Plans

With passage of the Intermodal Surface Transportation Efficiency Act of 1991 (ISTEA), states and Metropolitan Planning Organizations or MPOs (transportation planning agencies in metropolitan areas with populations of 50,000 or more) are required to develop and maintain long-range transportation plans. Further, ISTEA and its successor, the Transportation Equity Act for the 21st Century (TEA-21), require that bicyclists and pedestrians be given due consideration in state and MPO long-range transportation plans.

#### Transportation Improvement Programs

TEA-21 also requires states and MPOs to develop Transportation Improvement Programs (TIPs). TIPs are short-range plans that identify transportation projects to be funded and implemented in the next 3-5 years. Projects listed in the TIPs must be consistent with their respective state and local long-range transportation plans.

## Private Development

### Getting Projects in Local Plans

Many municipalities follow national guidelines for capital improvement plans (CIPs). Three of the recommendations for developing a CIP are of interest to pedestrian and bicycle advocates:

- The process for developing the plan should allow ample opportunity for stakeholder involvement in prioritizing projects and review.
- The capital improvement plan should take into account overall affordability in terms of both capital and operating costs, community concerns, available alternatives, coordination with other projects (including projects being considered by other governmental entities), impacts on services, beneficiaries of the project, and important community goals such as those related to economic development or the environment.
- An evaluation of capital financing alternatives should address equity considerations, or who will pay for the project in relation to who benefits from it.

**B**icycle and pedestrian facilities are also built and paid for by private developers as part of their projects. This might involve improving streets on property frontage or building entirely new public streets and intersections. In many rapidly growing areas, private sources fund the majority of new projects.

Your local government can require facilities as part of project approval and review the site design for compliance with adopted standards. But exceptions are often made during the review process and, depending on the agency, there may be little public involvement. You may not even hear of the project details until they are approved, at which time it may be too late to make meaningful changes.

For these types of projects, your strategy is to be connected with the people making decisions and to get good road design standards and development codes adopted. If you can, keep in touch with developers, bankers, planners, commission members, legislators and others who can help.

Get someone who's familiar with planning to review your local or state standards and codes. Find out where and what changes need to be made. Get help to develop a list of specific changes and improvements you want included. Most agencies update their standards and codes as needed (for example, to respond to disability requirements or policy changes). Although the code development process is not always set up for much public input, your contacts with decision-makers will help get attention to your issues when the time comes.

The underlying land-use policies and plans may need changing to support more pedestrian- and bicycle-friendly development. Land-use practices vary significantly around the country. Some states have comprehensive land-use laws that are directly tied to multi-modal transportation, whereas other states barely regulate land use. In either case, local governments generally have significant power to manage development. You can learn more about land-use planning from resources listed in Chapter 4.



**Large or controversial developments can benefit from public workshops to gather input and sketch out designs. This is an ideal time to focus on bicyclist and pedestrian needs.**

# Identify Funding Sources

**F**unds for pedestrian and bicycle projects generally come from the following sources:

- State or local transportation funds, usually as part of a larger road project.
- TEA-21 funds, administered by state or local agencies.
- Local revenue sources.
- Private donations.
- A combination of the above.

Keep in mind that the names of individual funding programs may vary from location to location. The following discussion will introduce you to the general types of funding sources that are being used for pedestrian and bicycle projects.

## State and Local Funding for Road Projects

**D**epending on where you live, most street projects may be managed by the state DOT or by a local transportation agency. Check with your local agency to find out who is responsible for the various streets and highways in your area. If it's the state, the state's bicycle and pedestrian coordinator can help.

New road construction and modernization projects (added lanes, intersections, etc.) always should include pedestrian and bicycle components, such as sidewalks, crossings and paved shoulders. These provisions are typically a minor portion of the total cost of a larger project. If a proposed project doesn't provide for pedestrian and bicycle needs, it may have been improperly scoped and may not meet federal and state guidelines. Request that the project be redesigned and that scoping procedures be improved in the future.

## Federal Funding Programs

**O**ver the past 10 years, ISTEA ("Ice Tea") and TEA-21 have become the flagship programs for pedestrian and bicycle facility funds. TEA-21 provides more than 26 billion dollars annually for planning, design, construction and reconstruction of the nation's transportation facilities. It is from this legislation that all states and U.S. territories get their federal transportation funds, which are raised by gasoline taxes and are then redistributed to the states. A large portion of "state" funds used for transportation projects and programs is really just a redistribution of federal funds, which emanate from TEA-21 (see sidebar page 29).

ISTEA dramatically changed the way the United States conducts its highway construction and funding activities, especially in the way it required states to consider pedestrians and

### State Bicycle & Pedestrian Coordinators

Go to

[www.fhwa.dot.gov/  
environment/bikeped/  
bipedcor.htm](http://www.fhwa.dot.gov/environment/bikeped/bipedcor.htm)

bicycling in the transportation mix and allowed states greater flexibility in funding programs and projects related to walking and bicycling.

TEA-21 succeeded ISTEA. It sustained the principal programs of ISTEA and provided even greater federal support for bicycling and walking by retaining important provisions in planning; adding new policies, programs and standards to accommodate walking and bicycling; and creating new funding opportunities to benefit these modes. It is expected that the federal transportation program that will succeed TEA-21 in 2003 will continue pedestrian and bicycle programs and funding through the current decade.

TEA-21 includes the two most popular sources of funds for pedestrian and bicycle facilities created under ISTEA: *Transportation Enhancement Activities* and the *Congestion Mitigation and Air Quality Programs*, described in the following sections.

TEA-21 also modified the safety set-aside (Hazard Elimination) program to make projects to improve the safety of pedestrians and bicyclists eligible for federal safety funds.

Finally, TEA-21 expanded the scope of the National Highway System (NHS) to include projects that accommodate bicycles and pedestrians. In fact, most of the TEA-21 program funds can be used for bicycle and pedestrian facilities, if state and local authorities are willing to do so!

### **Transportation Enhancements Program**

The Transportation Enhancements (TE) Program is the most common source of funds for pedestrian and bicycle facilities. Each state is required to set aside 10 percent of its annual Surface Transportation Program funds for Transportation Enhancement Activities (TEAs). Eligible funding categories include:

- pedestrian and bicycle facilities;
- pedestrian and bicycle safety and educational activities; and
- conversion of abandoned railway corridors to trails.

Other eligible TEA funding categories that can indirectly enhance the pedestrian and bicycling experience include:

- scenic or historic highway programs, including tourist and welcome centers, which may include designation signs and markers;
- landscaping and scenic beautification, including improvements such as street furniture, lighting, public art and landscaping;
- historic preservation;
- rehabilitation and operation of historic transportation buildings, structures or facilities; and
- control and removal of outdoor advertising.

#### **Transportation Enhancements**

See the National Transportation Enhancements Clearinghouse at [www.enhancements.org](http://www.enhancements.org) for detailed information.

Some typical improvements funded through the Transportation Enhancements Program include:

- Streetscape improvements.
- Sidewalks and crosswalks.
- Curb extensions at corners.
- Pedestrian light fixtures.
- Benches and landscaping.
- Information kiosks.
- Pedestrian and bicycle access across barriers.
- Pedestrian and bicycle trails and pathways.
- Bicycle racks on buses.
- Bicycle route signing.
- Bicycle parking facilities.
- Rail-to-trail conversions.

### State Transportation Enhancement Programs

The specifics of TE programs vary from state to state. Each state devises its own application and selection process, establishes selection criteria, and adopts methods to streamline the development and management of projects.

No two state TE programs are exactly alike. However, all state programs have these basic features: 1) eligibility criteria, 2) selection criteria, 3) selection cycle, 4) advisory committees, 5) project implementation, 6) innovative financing, and 7) streamlined project development.

In addition, all states have:

- A unique funding level for TEs through 2003 based on a formula set in TEA-21.
- A TE coordinator who administers the program with oversight by an FHWA TE coordinator.
- Requirements that call for a public entity with taxing authority to sponsor or endorse an applicant's project.
- Conditions that require any phase of a project that uses TE funds to comply with all state and federal requirements for developing and contracting transportation projects.

Beyond these aspects, state approaches vary.

**Eligibility.** The 12 categories of activities identified by the federal legislation are not recognized by all states. Some states lump eligible activities into broad groups, such as nonmotorized transportation, scenic beautification, historic preservation and environmental mitigation. Other states do not allow funding of certain categories and projects.

**Selection criteria.** Many states devise unique criteria to simplify the project-selection process. For example, minimum or maximum award amounts may apply; sponsors may be limited in the number of awards received; and a local funding match of

#### TE Coordinators

Go to

[www.enhancements.org/  
directory.html](http://www.enhancements.org/directory.html)

more than 20 percent may be required. To ensure projects contribute to local priorities and are feasible, other factors may be used to score or rank applications.

**Selection cycles.** Some states evaluate TE projects continuously. Other states review and select projects quarterly, annually or biennially.

**Advisory committees.** To increase chances of receiving an award, become familiar with the advisory committee process. Most states have advisory committees, but their duties, composition and appointments vary. Citizen advisors may be appointed for the expertise they bring to the selection process, or committee membership may be limited to state employees and elected officials.

**Project implementation.** Project costs that are reimbursable in one state may not be in another. Some states fund construction, but not planning, preliminary design or particular costs such as utility relocation.

**Innovative financing.** A local match of at least 20 percent is usually required. Many states allow other agencies to contribute to that match or allow in-kind donations, such as the value of land and labor, to qualify as the local share. In many cases, a greater match will increase chances for project selection.

**Streamlined project development.** Many states have flexible project review requirements, such as exemption from rigorous environmental impact reviews for certain projects or allowance for innovation in project management requirements. Some states require project applicants to attend training sessions before submitting an application, which often results in simplification of paperwork, shorter timelines and elimination of cost overruns.

### **Congestion Mitigation and Air Quality Improvement Program**

The second most popular source of funds for pedestrian and bicycle facilities is the Congestion Mitigation and Air Quality (CMAQ) Improvement Program. This program provides funding to areas that are officially designated by the U.S. Environmental Protection Agency as air quality “non-attainment” or “maintenance” areas. CMAQ funds in both areas must be spent on projects that help to reduce ozone (smog), carbon monoxide or particulate matter (soot) pollution. Every state, even those with no non-attainment areas, receives a minimum amount of CMAQ funding that it may spend on pollution-reduction programs, which can include pedestrian- and bicycle-related projects.

Types of improvements funded through the CMAQ program include:

- Bicycle lane striping.
- Bicycle parking facilities.
- Sidewalks and paths.

#### **CMAQ Improvement Program**

For more information, go to [www.fhwa.dot.gov/environment/cmaq/](http://www.fhwa.dot.gov/environment/cmaq/).

- Bicycle maps.
- Pedestrian and bicycle commuter education and promotion.

For example, in 1994 New York City transportation and planning departments received \$1.5 million in CMAQ funding to plan and implement a comprehensive bicycle network. As part of this effort, a Bicycle Master Plan identified a 500-mile network of bikeways throughout the five boroughs and the first-ever New York Cycling Map was produced.

Since 1994, the city has been implementing bikeways identified in the Master Plan. In 1996, an additional \$2.4 million was received to continue the program and to include the Department of Parks and Recreation in the plan.

Before receiving this funding, New York City had 56 miles of bike lanes. Since that time, more than 50 miles have been added. This, combined with 75 miles of greenway paths (8 miles of which have been added since ISTEA funding), brought the total bicycle network to more than 180 miles.

### Hazard Elimination

TEA-21 expanded eligible uses of Surface Transportation Program (STP) safety set-aside funds to include safety improvements for pedestrians and bicyclists. In addition, Hazard Elimination (part of the STP safety set-aside) funds can now be used for pedestrian and bicyclist pathways, trails and facilities. Traffic-calming projects are also specifically mentioned as eligible activities. Types of improvements that could be funded through the Hazard Elimination Program include:

- Safe routes to school programs.
- Replacement of unsafe “wheel-grabber” drainage grates.
- Improvements to and repair of publicly owned bicycle paths or trails.
- Traffic calming in neighborhoods and school areas.

For example, in October 2001 California extended its popular Safe Routes to School using one-third of their STP safety set-aside funds. The program will provide about \$70 million over the next three years for new sidewalks, bike lanes, trails and other projects to encourage students to walk or bike to school.

“It’s a little bit of money that will go a long way towards safer streets, more vital neighborhoods and healthier kids,” says James Corless, California Director of the Surface Transportation Policy Project (STPP). The program responds to sobering statistics showing that fewer children are walking or bicycling to school, and that parents driving their children to school make up nearly a quarter of morning and afternoon rush-hour traffic. Demand for the program has been tremendous. Schools requested more than five times the funding that was available during the first two rounds of grant applications.



### New York City Bicycle Master Plan

For more information, go to  
[www.nyc.gov/html/dot/html/  
get\\_around/bike/  
bikemain.html](http://www.nyc.gov/html/dot/html/get_around/bike/bikemain.html).

### California Safe Routes to School

For more information,  
see website of the  
California Bicycle Coalition,  
[www.calbike.org](http://www.calbike.org).

More than 60 organizations statewide supported the legislation authorizing the program, including the California PTA and the League of California Cities.

### Other STP funds

Surface Transportation Program funds for pedestrian and bicycle facilities are not restricted to the enhancements, CMAQ or safety set-aside programs. All STP funds may be used to facilitate walking and bicycling, although state departments of transportation typically use most of their STP funds for construction, reconstruction, repair or maintenance of highways for motor vehicle users. Additional types of improvements that can be funded through the STP program include:

- Construction of pedestrian and bicycle facilities in conjunction with ongoing highway improvements.
- Nonconstruction projects, such as maps, brochures and public service announcements, related to pedestrian and bicycle safety.

### Other TEA-21 Funding Sources

National Highway System funds may be used to construct bicycle transportation facilities and pedestrian walkways on land adjacent to any highway on the National Highway System, including interstate highways. Types of improvements funded through the NHS program include:

- Shoulder and sidewalk improvements on highways.
- Trails on adjacent rights-of-way.
- Intersection improvements.

Recreational Trails Program funds may be used for all kinds of trail projects. Of the funds apportioned to a state, 30 percent must be used for motorized trail uses, 30 percent for nonmotorized trail uses, and 40 percent for diverse trail uses (any combination). Types of improvements funded through the Recreational Trails Program include:

- Off-road (unpaved) trail improvements.
- Trailhead facilities and signing.
- Trail user education.

National Scenic Byways Program funds may be used for “construction along a scenic byway of a facility for pedestrians and bicyclists.” Scenic byways designations are requested by communities seeking to recognize roads with special scenic, natural, historic, cultural, recreational or archaeological features. These roadways are an opportunity for communities to highlight their assets, attract visitors and realize economic benefits from tourism and recreation.

#### Recreational Trails Program

For more information, go to [www.fhwa.dot.gov/environment/rectrail.htm](http://www.fhwa.dot.gov/environment/rectrail.htm).

#### National Scenic Byways Program

For more information, go to [www.byways.org](http://www.byways.org) and [scenic.org](http://scenic.org).



## Local Revenue Sources

### Property Taxes

Local governments use property taxes as their principal source of revenue. Property taxes usually flow into a general fund used to pay for the operation of local government. Some municipalities are able to use property taxes for capital improvement projects. Other communities may not be allowed to use monies in the general fund for street improvements or maintenance or projects that voters have approved.

### Local Improvement Districts

Where a group of property owners agree that improvements are needed in their immediate neighborhood, they also may agree to pay for such improvements through an assessment levied by the local government. Payments can span a number of years and may be based on the linear frontage of property, predicted trips generated by the development or other criteria. A local ordinance must be enacted to establish a local improvement district and related conditions. Local improvement districts are sometimes known as urban renewal districts, economic improvement districts or business improvement districts.

### Impact Fees

Impact fees are a way to fund public infrastructure associated with new development. The idea is to have developers share the cost of improvements required to support the increased demand their projects cause on transportation, water and sewer, schools or other public services. Impact fees usually apply to public improvements directly associated with new development. They typically are not used for general infrastructure improvements. If the impact of a development is not immediate, then fees may be put in a fund to help pay for improvements elsewhere in the community.

### Exactments

An exactment is a charge or obligation levied in exchange for permission to develop land. Where local governments place the burden of road improvements on abutting landowners and developers, an exactment can be used to require installation of a sidewalk or other improvement in the public right-of-way adjacent to the landowner's property. Exactments are best used for spot improvements or where specific sidewalk sections are missing. However, there is no way to be sure when a developer might submit an application. Further, a municipality needs to have a policy to require exactments when it benefits the community. The preferred option is to have the municipality assume responsibility for construction and maintenance of the pedestrian infrastructure, just as they do for local roads, instead of requiring property owners to assume this obligation.

## Private Donations

Private donations can range from corporate investment to individual contributions towards the cost of a community project. Although these sources should not be relied upon too heavily, they have the significant advantage of demonstrating community support for the project. This can be of tremendous help in convincing municipal governments to fund the balance of a project.

Major employers, such as businesses, hospitals and universities, are always potential benefactors of civic improvements that can encourage foot traffic and additional economic investment in downtown locations. For example, in the 1970s a group of business people in Corning, New York, home to 12,000 people and Corning Glass Works, recognized that the economic health of their downtown relied on a vital downtown core and the tax revenue it provided. Today, after an investment of several million dollars in private and public improvements, Corning is one of the most attractive and walkable cities in the Northeast.

Because some pedestrian and bicycle improvements are small and specific, even individuals can participate in making their communities more friendly to walking and bicycling. Many communities have aptly demonstrated their ability to involve local citizens by obtaining commitments to purchase and install bicycle racks (at \$250 per rack per donor) or to have walking surfaces embossed with the name of the contributor or a loved one (as little as \$100 per brick). School students in Oregon have constructed curb ramps, benches and planters as part of learning new skills.

## Follow Through with the Project

**D**o not relax after a project is approved and funded. Keep in touch with the project manager during the design to learn how your objectives are being addressed. Arrange a site visit to look at special problems. If nonstandard elements, such as lane widths, are desired, make sure these are approved.

Sometimes a project may be assigned a new manager, in which case it is wise to go through the history of the project with the new person because they may not be aware of the original discussions and community objectives.

During project construction, check with the project manager on progress and any issues that may come up. Some design decisions are necessarily made in the field, and you want to make sure they are consistent with the project's objectives. Finally, do a walkthrough of the completed project and congratulate the manager and team on a job well done! Remind people to hold a celebration to publicize the improvements and to get good publicity for officials who supported it.

## Summary

**C**onsiderable money is spent on transportation, but directing it to bicycle and pedestrian projects is easier said than done. Start by surveying the many funding sources and how they can be used.

Next, figure out the local process (state, region or municipality) for obtaining those sources. Match your projects (small or large; local or an entire area; retrofit or new) with likely funding sources. Combine sources where practical, using small amounts to leverage larger ones.

Make sure general roadway projects include adequate provisions for pedestrians and bicyclists. Get good codes adopted for your community and make sure they are followed. Ensure that transportation policy and project decisions improve walking and bicycling. Show decision-makers how an active community design is a good investment (see Chapter One).

Finally, keep on top of projects. Many take years to complete. People may come and go, and new staff may not understand the nature of the project and its role in community health. You can help to provide that continuity.



The **National Center for Bicycling & Walking** is a nonprofit organization that has been working for more bikeable and walkable communities since 1977. Since 1996 the NCBW has focused on involving the public health community in transportation policy and land-use planning to help create more physically active communities.



# Resources

## Public Health Facts & Figures

- Jackson, R.J., Kochtitzky, C. *Creating A Healthy Environment: The Impact of the Built Environment on Public Health*. Washington, DC: Sprawl Watch Clearinghouse, 2001. A report by doctors and researchers with the Centers for Disease Control and Prevention finds several primary connections between suburban sprawl and public health. Download at [www.sprawlwatch.org/health.pdf](http://www.sprawlwatch.org/health.pdf).
- [www.bikewalk.org/PubHealth.htm](http://www.bikewalk.org/PubHealth.htm). Washington, DC: National Center for Bicycling & Walking (NCBW). Introduces public health concepts and tools to promote healthy communities and nonmotorized transportation.
- [www.cdc.gov/nccdphp/dnpa](http://www.cdc.gov/nccdphp/dnpa). Atlanta, GA: National Center for Chronic Disease Prevention and Health Promotion. A Centers for Disease Control and Prevention (CDC) website that provides much information on nutrition and physical activity. Available slides provide an effective, dramatic presentation on the consequences (and magnitude) of the physical inactivity and obesity problem. The slides are at [www.cdc.gov/nccdphp/dnpa/obesity/trend/maps/index.htm](http://www.cdc.gov/nccdphp/dnpa/obesity/trend/maps/index.htm).

## Transportation Facts & Figures

- *Mean Streets 2000*. Surface Transportation Policy Project (STPP), 2000. The report examines pedestrian safety problems through analysis of federal safety, health and spending statistics. Identifies cities where pedestrians are most at risk. One of several reports produced by STPP and available on their website. [www.transact.org/Reports/ms2000](http://www.transact.org/Reports/ms2000).
- [www.bikewalk.org/data\\_&\\_statistics.htm](http://www.bikewalk.org/data_&_statistics.htm). A National Center for Bicycling & Walking (NCBW) website that provides an introduction to data and statistics on nonmotorized travel.

### Chapter Four: Resources

Public Health Facts & Figures .....	41
Transportation Facts & Figures .....	41
Land-Use Planning & Community Design .....	42
Facility Planning & Design .....	43
Schools .....	44
Funding Sources & Programs .....	44
Advocacy .....	45
Glossary & Index .....	46

# Land-Use Planning & Community Design

## America WALKs

P.O. Box 29103  
Portland, Oregon 97296  
Tel: (503) 222-1077  
Fax: (503) 228-0289  
Email: [info@americawalks.org](mailto:info@americawalks.org)  
[www.americawalks.org](http://www.americawalks.org)

## National Center for Bicycling & Walking

1506 21st Street, NW Suite 200  
Washington, DC 20036  
Tel: (202) 463-6622  
Fax: (202) 463-6625  
Email: [info@bikewalk.org](mailto:info@bikewalk.org)  
[www.bikewalk.org](http://www.bikewalk.org)

## Centers for Disease Control and Prevention

1600 Clifton Rd.  
Atlanta, GA 30333  
Tel: (800) 311-3435  
Email (web): [www.cdc.gov/netinfo.htm](http://www.cdc.gov/netinfo.htm)  
[www.cdc.gov](http://www.cdc.gov)

- Burden, D. *Street Design Guidelines for Healthy Neighborhoods*. Sacramento, CA: Local Government Commission, 1999. A 52-page guide to help local governments and community leaders be proactive in their land-use and transportation planning, and to adopt programs and policies that lead to more livable and resource-efficient land-use patterns. Order at [www.lgc.org](http://www.lgc.org).
- Burden, D. *Streets and Sidewalks, People and Cars: The Citizen's Guide to Traffic Calming*. Sacramento, CA: Local Government Commission, 2001. A 52-page guide to help communities better understand the dynamics of vehicle and pedestrian movement, identify traffic-calming opportunities and recommend street improvements. Order at [www.lgc.org](http://www.lgc.org).
- Kulash, W.M. *Residential Streets*. Washington, DC: Urban Land Institute, 2001. The 76-page guide describes practical approaches to planning and designing residential streets and enhancing livability. Order at [www.uli.org](http://www.uli.org).
- *Main Street...When A Highway Runs Through It: A Handbook for Oregon Communities*. Salem, OR: Oregon Transportation and Growth Management Program, 1999. A 102-page handbook for communities with a main street that is also a state highway. Provides many examples of design options applicable to all main streets. Order or download at [www.lcd.state.or.us/tgm/publications.htm](http://www.lcd.state.or.us/tgm/publications.htm).
- *New Community Design to the Rescue: Fulfilling Another American Dream*. Washington, DC: National Governors' Association. Report explains how states and communities can encourage New Community Design — mixed-use, mixed-income, walkable development that is distinctly different from sprawl — by eliminating institutional barriers in the marketplace. Order or download from [www.nga.org](http://www.nga.org).
- [www.bikewalk.org/cdc\\_active\\_community\\_environments.htm](http://www.bikewalk.org/cdc_active_community_environments.htm). National Center for Bicycling & Walking (NCBW) website describes Active Community Environments (ACEs) and provides links to related resources, such as the CDC website at [www.cdc.gov/nccdphp/dnpa/aces.htm](http://www.cdc.gov/nccdphp/dnpa/aces.htm).
- [www.bikewalk.org/smart\\_growth.htm](http://www.bikewalk.org/smart_growth.htm). National Center for Bicycling & Walking (NCBW) website discusses smart growth and provides links to related resources.
- [www.lgc.org/center/index.html](http://www.lgc.org/center/index.html). Sacramento, CA: Center for Livable Communities, Local Government Commission (LGC). Website helps governments to identify and implement solutions to today's problems. The LGC provides a forum and technical assistance for local governments to create and

sustain healthy environments, healthy economies and social equity.

- [www.sierraclub.org/sprawl](http://www.sierraclub.org/sprawl). San Francisco, CA: Sierra Club. Website provides a list of publications and a forum for discussing sprawl and its impacts.
- [www.vtppi.org](http://www.vtppi.org). The Victoria Transport Policy Institute is an independent research organization dedicated to developing innovative and practical solutions to transportation problems. They provide many free, up-to-date resources to help address the challenges of effective nonmotorized transportation planning and policy analysis.

## Facility Planning & Design

- Ewing, R. *Traffic Calming: State of the Practice*. Washington, DC. Institute of Transportation Engineers (ITE), 1999. Report contains a synthesis of traffic-calming experiences to date in the United States and Canada. Includes information on traffic calming in residential areas and in areas where high-speed rural highways transition into rural communities. The intended audience is transportation professionals. Order or download at [www.ite.org/traffic/tcstate.htm](http://www.ite.org/traffic/tcstate.htm).
- Flink, C. A., et al. Rails-to-Trails Conservancy. *Trails for the Twenty-First Century (Second Edition): Planning, Design, and Management Manual for Multi-Use Trails*. Washington, D.C.: Island Press, 2001. For planners, landscape architects, local officials and community activists interested in creating a multi-use trail. Order at [www.islandpress.com/books](http://www.islandpress.com/books).
- *FHWA Guidance on the Bicycle and Pedestrian Provisions of the Federal-Aid Program*. Guidance for state DOTs and MPOs on implementing pedestrian and bicycle components of the Transportation Equity Act for the 21st Century (TEA-21). Guidance and transmittal letter from the FHWA Administrator are available on line at [www.bikewalk.org](http://www.bikewalk.org).
- *Guide for the Development of Bicycle Facilities (3rd Edition)*. Washington, DC. American Association of State Highway and Transportation Officials (AASHTO), 1999. The most referenced bicycle-facility document in the U.S. Order from [www.aashto.org](http://www.aashto.org).
- *Implementing Bicycle Improvements at the Local Level*. Washington, DC: Bicycle Federation of America (now the NCBW). Report for the Federal Highway Administration. Written for local governments, advocates and others who want to improve existing conditions for bicyclists. Download at [www.bikewalk.org/bike\\_guide\\_online.htm](http://www.bikewalk.org/bike_guide_online.htm).
- *Implementing Pedestrian Improvements at the Local Level*. Washington, DC: Bicycle Federation of America (now the NCBW). Report produced for the Federal Highway Administration. It outlines typical problems confronting pedestrians and

### Local Government Commission

1414 K St, Ste 600  
Sacramento, CA 95814  
Tel: (916) 448-1198  
Fax: (916) 448-8246  
Email: [info@lgc.org](mailto:info@lgc.org)  
[www.lgc.org](http://www.lgc.org)

### Pedestrian and Bicycle Information Center

730 Airport Road, Suite 300,  
Campus Box 3430  
Chapel Hill, NC 27599  
Tel: (919) 962-2203  
Fax: (919) 962-8710  
Email: [pedbike@willow.hsrc.unc.edu](mailto:pedbike@willow.hsrc.unc.edu)  
[www.pedbikeinfo.org](http://www.pedbikeinfo.org)

### Sprawl Watch Clearinghouse

1400 16th Street NW, Suite 225  
Washington, DC 20036  
Tel: (202) 332-7000  
Fax: (202) 265-0182  
Email: [allison@sprawlwatch.org](mailto:allison@sprawlwatch.org)  
[www.sprawlwatch.org](http://www.sprawlwatch.org)

**Office of the Surgeon General**  
 U.S. Department of Health and  
 Human Services  
 Public Health Service  
 200 Independence Avenue, S.W.  
 Washington, D.C. 20201  
 Tel: (877) 696-6775  
 Email: [hhs@mail@os.dhhs.gov](mailto:hhs@mail.os.dhhs.gov)  
[www.surgeongeneral.gov](http://www.surgeongeneral.gov)

**Surface Transportation Policy  
 Project**

1100 17th St. NW, 10th Floor  
 Washington, DC 20036  
 Tel: (202) 466-2636  
 Fax: (202) 466-2247  
 Email: [stpp@transact.org](mailto:stpp@transact.org)  
[www.transact.org](http://www.transact.org)

**Walkable Communities, Inc.**

320 S. Main St.  
 High Springs, FL 32643  
 Tel: (386) 454-3304  
 Fax: (386) 454-3306  
 Email: [DBurden@aol.com](mailto:DBurden@aol.com)  
[www.walkable.org](http://www.walkable.org)

provides information on actions that can be taken by local governments and others to improve conditions for walking. Download at [www.bikewalk.org/pedestrian\\_guide.htm](http://www.bikewalk.org/pedestrian_guide.htm).

- [www.enhancements.org](http://www.enhancements.org). The National Transportation Enhancements Clearinghouse (NTEC), an online information service sponsored by the Federal Highway Administration (FHWA) and Rails-to-Trails Conservancy (RTC) to provide professionals, policy makers and citizens with information about transportation enhancements: how TE is implemented, how to make use of this provision of the nation's transportation program, an explanation of the TE program, documents about the program, a directory of people in each state who work with TE projects, and example projects.
- [www.pedbikeinfo.org](http://www.pedbikeinfo.org). Chapel Hill, NC: Pedestrian and Bicycle Information Center (PBIC). A clearinghouse for information about health and safety, engineering, advocacy, education, enforcement, access and mobility. The PBIC serves anyone interested in pedestrian and bicycle issues, including planners, engineers, private citizens, advocates, educators, police and the health community.

## Schools

- [www.bikewalk.org/safe\\_routes\\_to\\_school.htm](http://www.bikewalk.org/safe_routes_to_school.htm) and [www.bikewalk.org/walk\\_a\\_child\\_to\\_school.htm](http://www.bikewalk.org/walk_a_child_to_school.htm). Washington, DC: National Center for Bicycling & Walking (NCBW). Two NCBW websites about school transportation programs and links to related websites.

## Funding Sources & Programs

- *A Guide to Transportation Enhancements*. Washington, DC: Federal Highway Administration, June 1999. The 34-page guide describes the Transportation Enhancements program as provided under the Transportation Equity Act for the 21st Century (TEA-21), federal requirements for eligibility, how to navigate your way around state transportation agencies, a typical project development process, and 21 case studies of enhancement projects. See [www.fhwa.dot.gov](http://www.fhwa.dot.gov) and [www.enhancements.org](http://www.enhancements.org).
- *The Transportation Enhancement & Congestion Mitigation and Air Quality Programs*. Concord, NH: State of New Hampshire Department of Transportation, May 2001. An 82-page manual about the TE and CMAQ programs. Intended for use by current and potential sponsors of New Hampshire projects but useful for others who would benefit from a greater understanding of the funding processes. See [webster.state.nh.us/dot/municipalhighways/tehome.htm](http://webster.state.nh.us/dot/municipalhighways/tehome.htm).



# Advocacy

- *America WALKs*. A national coalition of walking advocacy groups dedicated to promoting livable communities, where people walk because it's a real choice. See [www.americawalks.org](http://www.americawalks.org).
- *Association of Pedestrian and Bicycle Professionals (APBP)*. A national nonprofit organization representing the interests of engineers, planners, advocates, academics and safety experts who work to improve conditions for bicyclists and pedestrians. See [www.apbp.org](http://www.apbp.org).
- *Guide to Bicycle Advocacy*. Brookline, MA: Bikes Belong Coalition, September 1999. A 40-page guide on how to make communities more bicycle friendly, TEA-21 and what it provides, what needs to be done and how to get what you want, and tools and tactics for advocacy. Download at [www.bikesbelong.org](http://www.bikesbelong.org) under Political Effectiveness.
- *League of American Bicyclists (LAB)*. A national organization that promotes cycling for fun, fitness and transportation. The LAB membership includes individuals, recreational clubs and advocacy organizations that share an interest in working through advocacy and education for a bicycle-friendly America. See [www.bikeleague.org](http://www.bikeleague.org).
- *National Center for Bicycling & Walking (NCBW)*. A nonprofit organization working for more bicycle-friendly and walkable communities. The NCBW offers information support, training, consultation services and resources to public agencies, non-governmental organizations and advocates, maintains an Internet support center, and organizes the biennial Pro Bike/Pro Walk conference series and other special meetings. See [www.bikewalk.org](http://www.bikewalk.org).
- *Pro Bike/Pro Walk conference series*. A biennial symposium on bicycling and walking sponsored by the National Center for Bicycling & Walking. Held during even-numbered years for anyone interested in improving conditions for bicycling and walking and the quality of life within their communities. See [www.bikewalk.org/conference.htm](http://www.bikewalk.org/conference.htm).
- *Rails-to-Trails Conservancy*. The nation's largest trails organization dedicated to connecting people and communities by a nationwide network of public trails, many built along former rail lines and connecting corridors. See [www.railtrails.org](http://www.railtrails.org).
- *Thunderhead Alliance*. A national coalition of more than 40 state and local bicycle advocacy organizations working to increase the capacity, funding, membership and strategic ability of bicycle advocacy organizations, while representing bicyclists' interests at the federal level. See [www.thunderheadalliance.org](http://www.thunderheadalliance.org).
- *Walkable Communities, Inc.* A nonprofit corporation dedicated to helping communities become more walkable and pedestrian-friendly. See [www.walkable.org](http://www.walkable.org).

# Glossary & Index

<i>ACE</i>	Active Community Environment. [pages 1, 5]
<i>Bike Lane</i>	A portion of the roadway designated for preferential use by bicyclists. [19]
<i>CDC</i>	Centers for Disease Control and Prevention. [1]
<i>CIP</i>	Capital Improvement Program. [29]
<i>CMAQ</i>	Congestion Mitigation and Air Quality Improvement Program. [34]
<i>Crosswalk</i>	Marked or unmarked area of an intersection where pedestrians cross, or a marked roadway crossing mid-block. Pedestrians have special rights at crosswalks. [17]
<i>Curb Extension</i>	A section of curb that extends into the roadway, which shortens crossing distance and improves pedestrian visibility. Also known as a bulb-out, neckdown, flare or choker. [18]
<i>Curb Radius</i>	The curved edge of the roadway at an intersection. [18]
<i>Design Speed</i>	A selected speed used to determine the various geometric design features of the roadway. [23]
<i>ISTEA</i>	Intermodal Surface Transportation Efficiency Act of 1991. Landmark legislation for balanced federal highway funding and the predecessor to TEA-21. [31]
<i>NCBW</i>	National Center for Bicycling & Walking. [41]
<i>NPTS</i>	Nationwide Personal Transportation Survey. [3]
<i>Shared Roadway</i>	Bicyclists and motorists share the travel lanes. [19]
<i>Shared-Use Path</i>	A facility separated from motor vehicle traffic by an open space or barrier, and typically used by pedestrians, joggers, skaters and bicyclists as two-way facilities. [21]
<i>Shoulder Bikeway</i>	Paved and smooth roadway shoulder at least 4 feet wide. [20]
<i>Sidewalk</i>	An improved facility for pedestrians that is usually, but not always, located in the public right-of-way next to a roadway and constructed of concrete or other hard, smooth surface. [13, 15]
<i>Smart Growth</i>	Community development pattern that is economically sound, environmentally friendly and supportive of community livability. [6, 24]
<i>TE</i>	Transportation Enhancement. [33]
<i>TEA-21</i>	Transportation Efficiency Act for the 21st Century. [31]
<i>TIP</i>	Transportation Improvement Program. [29]
<i>Traffic Calming</i>	A set of techniques that reduce the speed and aggressiveness of traffic. [23]
<i>TND</i>	Traditional Neighborhood Development. A human scale, walkable community with moderate to high residential densities and a mixed-use core. [6]
<i>Wide Outside Lane</i>	A lane of at least 14 feet that allows an average-size motor vehicle to safely pass a bicyclist without crossing over into the adjacent lane. [19]

